



GEA-03 (GPRS) Vehicle tracker

Specifications & Features

- Power Supply +9V - +35V / 1.5A (Backup Battery 850mAh)
- Frequency GSM 900/1800/1900Mhz or GSM 850/900/1800/1900Mhz
- Tracking via SMS or GPRS (TCP/UDP)
- GPS Module latest GPS SIRF-Star III chipset
- Channels 20 channel all-in-view tracking (Position Accuracy 10 meters, 2D RMS)
- Reacquisition 0.1 sec., average
- Hot start 1 sec., average
- Warm start 38 sec., average
- Cold start 42 sec., average
- LED 2 LED lights to show GPS/GSM working status.
- Flash Memory 8MB
- 5 digital inputs, 3 negative and 2 positive triggering;
- 2 analog inputs; 5 outputs.

Features:

- ❖ SOS emergency Alarm (panic button)
- ❖ Move Alarm (Built-in motion sensor)
- ❖ Over Speeding Alarm
- ❖ Real-time polling
- ❖ Geo-Fence
- ❖ Low Battery Alarm
- ❖ Compatible with original car alarm
- ❖ Built-in 8Mb memory data logger
- ❖ Built-in Motion sensor
- ❖ Built-in Li-ion Rechargeable battery,
- ❖ (working +/- 24hrs without power supplied from the car battery)

Examples of using the 5 digital inputs, and or 2 analog inputs; 5 outputs.

4.4 Examples of Interfacing Application

For Input Ports

1. SOS Button - Input 1 / Input 2 / Input 3

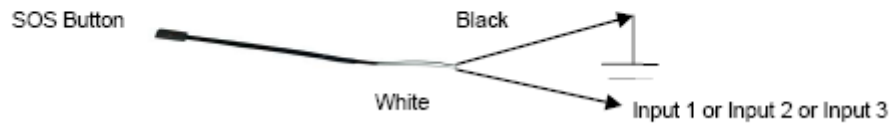

2. Ignition Detection - Input 4 / Input 5

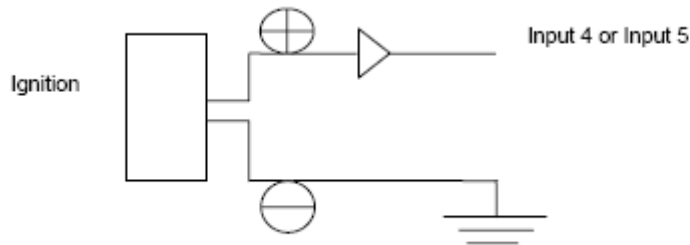

3. Detecting Lock Status of Car's Door or Trunk(Car Boot): Locked or Unlocked - Input 4 / Input 5

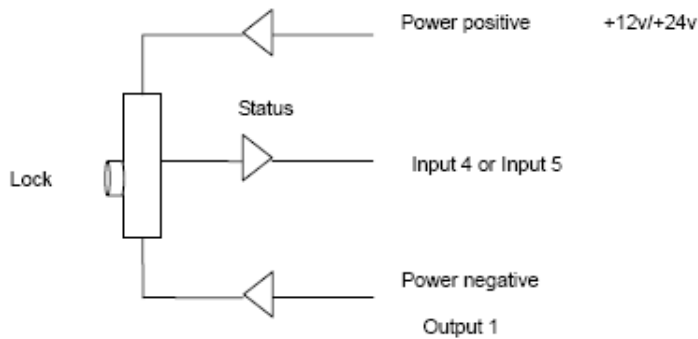

4. Connecting with Sensors (such as weight sensor) - Input 2 / Input 3

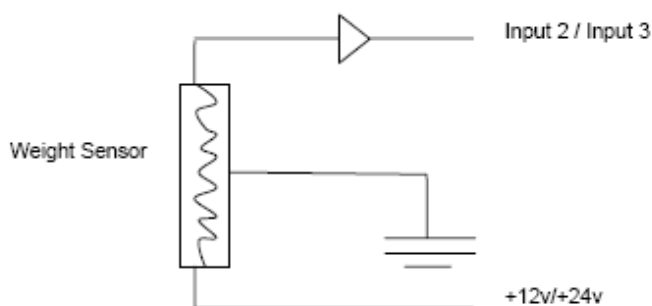

Examples of using the 5 digital inputs, and or 2 analog inputs; 5 outputs.

For Output Ports

1. Engine Cut



2. Connecting with Car Alarm



For Analog Input



Installation Guide:

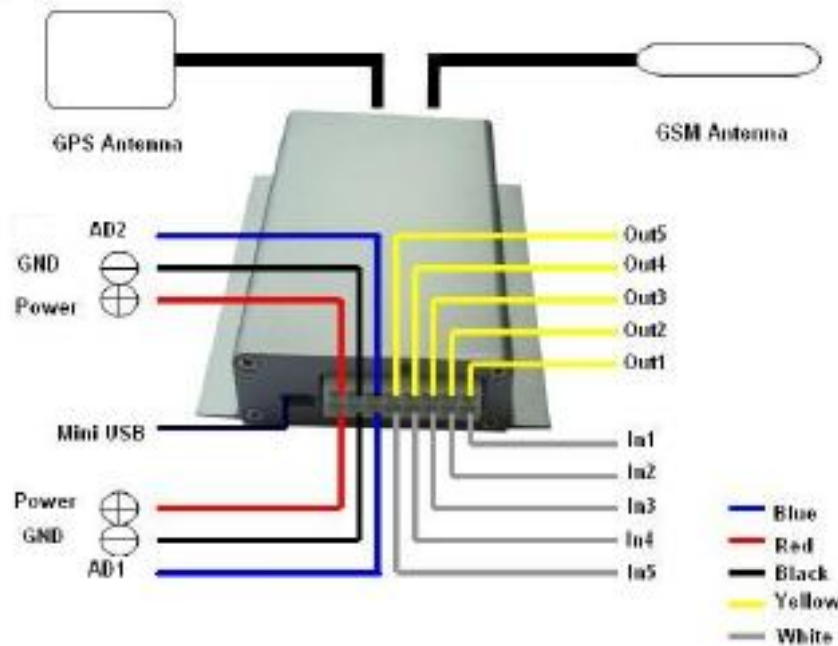

Descriptions of PINs

Pin	Color	Function
1	Red	DC In. Input voltage: 9V~35V. 12V suggested.
2	Black	GND
3	White	Digital Inputs
4	Yellow	Outputs
5	Blue	10 Bits Resolution Analog Inputs. Input voltage: 0~6V.

WEB server Life tracking application

Online GPS Tracking & Real Time Tracking - View Current Position - Windows Internet Explorer

http://www.webtrace.co.id/index.php?option=map&mapval=1&px=106.83515&py=-6.588295&level=16&map=jkt

Search Web Anti-Spy Upgrade your Toolbar Now Mail Answers Dating Y! Mobile Sign in

Favorieten News Aanbevolen websites My Yahoo! Meer invoegtoepassin... Yahoo! Yahoo! Bookmarks Yahoo! Mail

Online GPS Tracking & Real Time Tracking - View Curre... Pagina Beveiliging Extra

web based GPS tracking

Home | Account Settings | View | Support Welcome, demo | Logout

Map: Jakarta

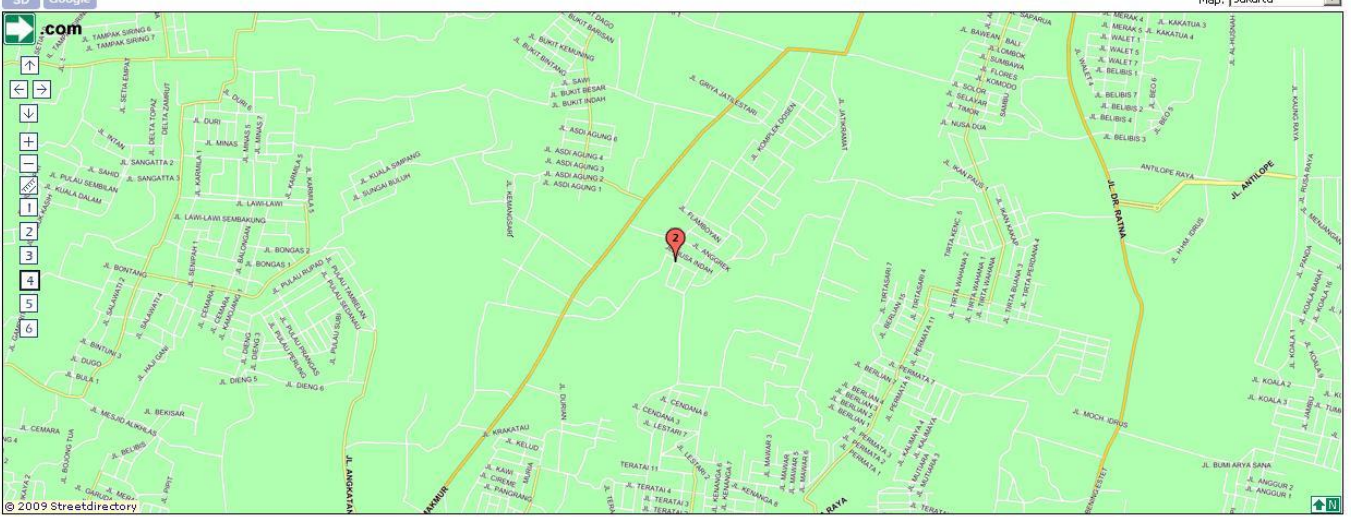

© 2009 Streetdirectory Contact: (65) 6474 4005 All rights reserved. Terms and conditions

Online GPS Tracking & Real Time Tracking - History - Windows Internet Explorer

http://www.webtrace.co.id/index.php?option=history

Search Web Anti-Spy Upgrade your Toolbar Now Mail Answers Dating Y! Mobile Sign in

Favorieten News Aanbevolen websites My Yahoo! Meer invoegtoepassin... Yahoo! Yahoo! Bookmarks Yahoo! Mail

Online GPS Tracking & Real Time Tracking - History Pagina Beveiliging Extra

Webtrace web based GPS tracking History

Home | Account Settings | View | Support Welcome, demo | Logout

Select Device: 111 Exclude Points > 500 meters

Quick History:
 Last 6 Hrs Last 12 Hrs Last 24 Hrs

Custom History:

By Time
Day: 08/08/2009
Start: 00:00 End: 24:00

By Date
Start: 08/08/2009 End: 08/08/2009

HISTORY PLAYBACK

Result List:

No.	Time	Location	Set Point	Zoom To Location
1	07:27:05 AM (08/08/2009)	unknown road (106.016192, -5.984292)	<input type="button" value="S"/> <input type="button" value="E"/>	<input type="button" value="GO"/>
2	07:36:03 AM (08/08/2009)	unknown road (106.024073, -5.989462)	<input type="button" value="S"/> <input type="button" value="E"/>	<input type="button" value="GO"/>
3	07:39:12 AM (08/08/2009)	unknown road (106.032092, -5.983550)	<input type="button" value="S"/> <input type="button" value="E"/>	<input type="button" value="GO"/>
4	07:42:02 AM	unknown road	<input type="button" value="S"/> <input type="button" value="E"/>	<input type="button" value="GO"/>

Playback Control

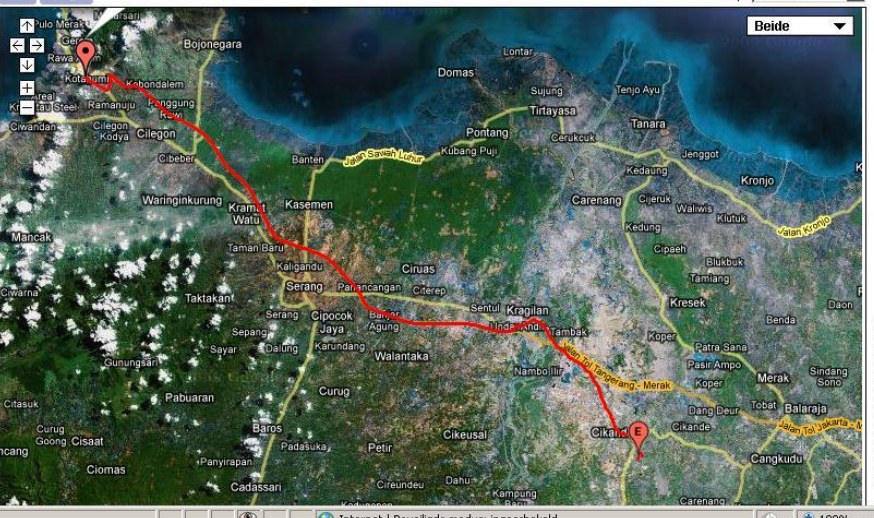

© 2009 Streetdirectory Contact: (65) 6474 4005 All rights reserved. Terms and conditions

Jakarta Head Office: Eropa Blok B-17 Kota Wisata Cibubur - Bogor 16968, Phone: +62 21-849-31031, Fax: +62 21-849-31037

Marketing Office: Jl. Amil No. 29A, Kalibata Pulo - Jakarta Selatan 12740, Phone: +62 21-3221-9646

WEB server Life tracking application

Online GPS Tracking & Real Time Tracking - View Current Position - Windows Internet Explorer

http://www.webtrace.co.id/index.php?option=map&mapval=28&px=697735.992579&py=9307999.982706&level=0&cmmap=jkt

Search Web Anti-Spy Upgrade your Toolbar Now Mail Answers Dating Y! Mobile Sign in

Favorieten News Aanbevolen websites My Yahoo! Meer invoegtoepassin... Yahoo! Yahoo! Bookmarks Yahoo! Mail

Online GPS Tracking & Real Time Tracking - View Curre...

Webtrace web based GPS tracking

View Current Position

Home | Account Settings | View | Support Welcome, demo | Logout

SD Google Map: Beide

Device : 111
Street Name : UNNAMED ROAD
Speed : 22 km/h

Afbeeldingen ©2009 DigitalGlobe, GeoEye, Kaartgegevens ©2009 AND, Tele Atlas, Europa Technologies - gebruiksvoorwaarden

Online GPS Tracking & Real Time Tracking - View Current Position - Windows Internet Explorer

http://www.webtrace.co.id/index.php?option=map&mapval=28&px=650932.788&py=9311977.148&level=5&cmmap=jkt

Search Web Anti-Spy Upgrade your Toolbar Now Mail Answers Dating Y! Mobile Sign in

Favorieten News Aanbevolen websites My Yahoo! Meer invoegtoepassin... Yahoo! Yahoo! Bookmarks Yahoo! Mail

Online GPS Tracking & Real Time Tracking - View Curre...

Webtrace web based GPS tracking

View Current Position

Home | Account Settings | View | Support Welcome, demo | Logout

List Device By: Device Name Search Device

Show	ID	Device	Last Time	Last Location
<input checked="" type="checkbox"/>	1	111	09:49:33 AM (Today)	UNNAMED ROAD (106.364210, -6.222795)
<input checked="" type="checkbox"/>	2	200000001	03:16:37 PM (07/08/2009)	UNNAMED ROAD (106.937891, -6.274336)
<input checked="" type="checkbox"/>	3	202200002	09:10:16 AM (23/06/2009)	UNNAMED ROAD (106.635150, -6.586295)

Select All Data Refresh Rate 30 sec Refresh

Enable Geofence Alert
 Enable Pop Up Alert

LEGEND:
 STATIONERY (Speed 0 km/h)
 MOVING (Speed > 0 km/h and Last Position less than 20 minutes ago)
 MOVING (Speed > 0 km/h and Last Position more than 20 minutes ago)

SD Google Map: Jakarta Beide

Afbeeldingen ©2009 TerraMetrics, Kaartgegevens ©2009 AND, Tele Atlas, Europa Technologies - gebruiksvoorwaarden

Start Verzonden items - Micros... Untitled - Message (HTML) Online GPS Tracking ... NL 9:50

Jakarta Head Office: Eropa Blok B-17 Kota Wisata Cibubur - Bogor 16968, Phone: +62 21-849-31031, Fax: +62 21-849-31037

Marketing Office: Jl. Amil No. 29A, Kalibata Pulo - Jakarta Selatan 12740, Phone: +62 21-3221-9646